









ANTENNAS | OMNI-293 SERIES

OMNI-DIRECTIONAL, WIDEBAND 5G/LTE ANTENNA

617 – 3800 MHz, 9 dBi



				5G READY	4G LTE
617 – 960 MHz; 1427 – 1517 MHz; 1710 – 2700 MHz; 3400 – 3800 MHz	9 dBi	Increase x Mb/s	Omni- Directional	5G Ready	4G LTE
3.5 GHz CBRS		BAND 71			
CBRS Band	IoT & M2M	617 – 698 MHz	Fire Resistant	-40°C to +80°C	IP 65

- **High performance, ultra-wideband omni-directional antenna**
- **Consistent high gain over wide frequency band**
- **Excellent broadband quality antenna**
- **Ideal for Machine to Machine (M2M) and IoT applications**
- **Dust and water-resistant enclosure with IP65 rating**



Product Overview

The OMNI-293 is an ultra-wideband, high performance, omni-directional antenna that covers the contemporary 4G/LTE and future 5G operating frequencies with excellent balanced gain across all frequencies. The ultra-wideband performance from the antenna allows it to operate from 617 to 3800 MHz, with a peak gain of 9 dBi. The antenna is future proof as it covers the up and coming 617 to 698 MHz band, as well as 3400 to 3800 MHz which will be utilized for future 5G applications. This makes the antenna usable in all parts of the world and guarantees signal reception almost everywhere. The antenna design allows for superior pattern control over the entire frequency range, making the OMNI-293 a true high performance omni-directional antenna, suitable for urban and rural applications. The exceptional wideband performance is an important factor for LTE and future 5G technologies, where these technologies rely on features such as Carrier Aggregation (CA) to provide the best possible reception and throughput over multiple frequency bands simultaneously. The antenna comes with an N-Type female connector at its base, which can be connected to a cable of the desired type and length.

Features

- High gain omni-directional antenna
- Includes 617 to 698 MHz band and 3.5 GHz 5G bands
- Wideband operation, makes the antenna future proof
- Antenna is purpose-built for urban and rural applications
- Robust and weather resistant design with IP65 rating

Application Areas

- Improve data transmission connection reliability & stability
- Machine to Machine (M2M) & IoT applications
- High-end industrial grade router applications
- Areas with poor data signal reception
- Enhanced 4G/LTE and 5G reception



Frequency Bands

The OMNI-293 is an omni-directional antenna that works from 617 – 960 MHz | 1427 – 1517 MHz | 1710 – 2700 MHz | 3400 – 3800 MHz

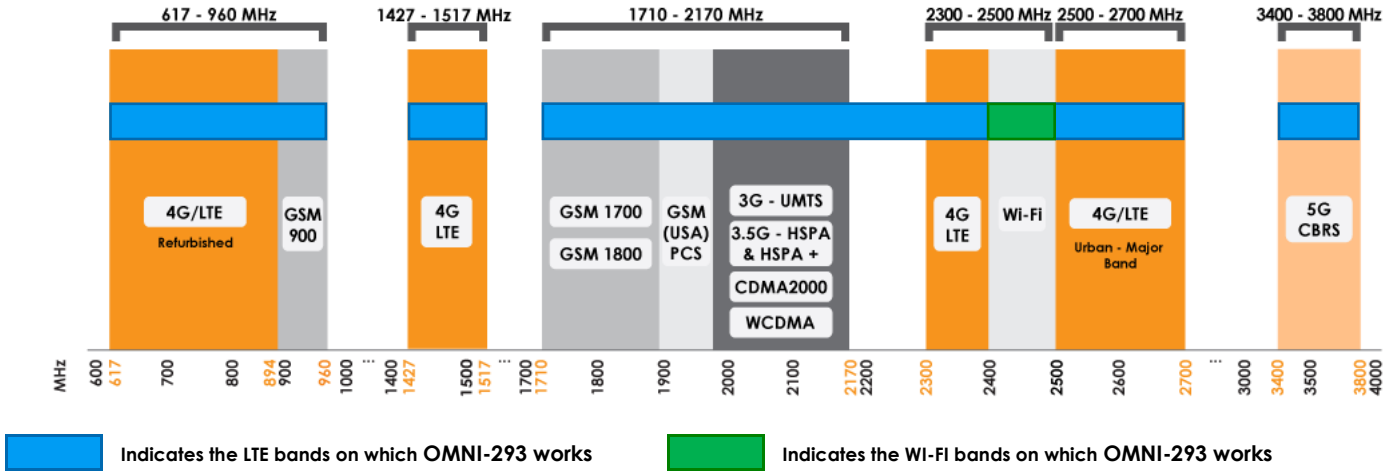

Antenna Overview

Ports	1
SISO / MIMO	SISO
Frequency Bands	617 – 3800 MHz
Polarisation	Linear Vertical
Peak Gain	9 dBi
Coax Cable Type	N/A
Coax Cable Length	N/A
Connector Type	N-Type (F)

**The connector is factory mounted to the antenna*

Electrical Specifications

Frequency bands:	617 – 960 MHz 1427 – 1517 MHz 1710 – 2700 MHz 3400 – 3800 MHz
Gain (max):	6 dBi @ 617 - 960 MHz 6 dBi @ 1427 - 1517 MHz 9 dBi @ 1710 – 2700 MHz 8 dBi @ 3400 -3800 MHz
VSWR:	<2.5:1 Over 90% of the bands

Feed power handling: 10 W

Input impedance: 50 Ohm (nominal)

Polarisation: Linear Vertical

DC short: Yes

Product Box Contents

Antenna:	A-OMNI-0293
Mounting bracket:	Pole up to 50mm diameter Wall and pole mount stainless steel bracket

Ordering Information

Commercial name: OMNI-293

Order product code: A-OMNI-0293-V1-01

EAN number: 6009710922347

Mechanical Specifications

Product dimensions: 635 mm x Ø71 mm
(excl. bracket)

Packaged dimensions: 700 mm x 95 mm x 90 mm

Radome material: ABS (Halogen Free)

Radome colour: Pantone - Cool Gray (1C)
RAL - 7047

Mounting Type: Wall and pole mount

Environmental Specifications, Certification & Approvals

Wind Survival: <160 km/h

Temperature Range (Operating): -40°C to +80°C

Environmental Conditions: Outdoor/Indoor

Water ingress protection ratio/standard: IP 65

Salt Spray: MIL-STD 810G/ASTM B117

Operating Relative Humidity: Up to 98%

Storage Humidity: 5% to 95% - non-condensing

Storage Temperature: -40°C to +70°C

Enclosure Flammability Rating: UL 94-HB

Impact resistance: IK 08

Product Safety & Environmental: Complies with CE and RoHS standards



Antenna Performance Plots

VSWR

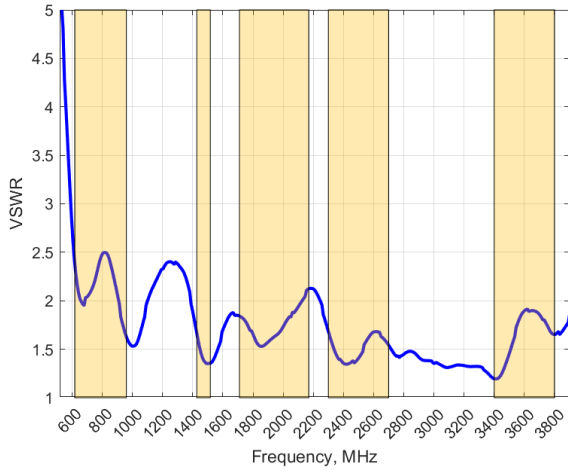

GAIN (EXCLUDING CABLE LOSS)

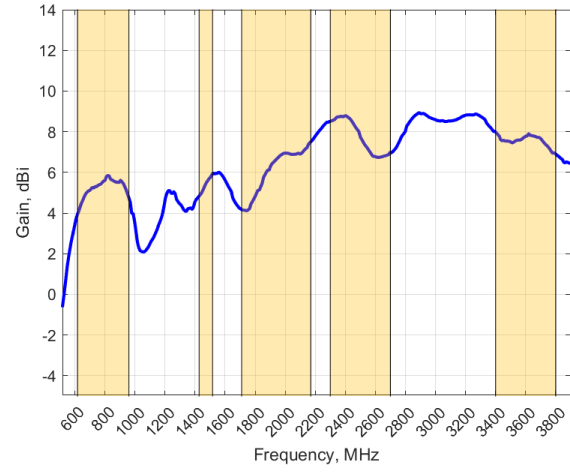

Voltage Standing Wave Ratio (VSWR)

VSWR is a measure of how efficiently radio-frequency power is transmitted from a power source, through a transmission line, into a load. In an ideal system, 100% of the energy is transmitted which corresponds to a VSWR of 1:1.

The OMNI-293 delivers superior performance across all bands with a VSWR of 2.5:1 or better over 90% of the bands.

**Antenna VSWR measured with a 2m low loss cable*

Gain* in dBi

9 dBi is the peak gain across all bands from 617 - 3800 MHz

Gain @ 617 – 960 MHz:	6 dBi
Gain @ 1427 – 1517 MHz:	6 dBi
Gain @ 1710 – 2700 MHz:	9 dBi
Gain @ 3400 – 3800 MHz:	8 dBi

**Antenna gain measured with polarisation aligned standard antenna*

Technical Drawings

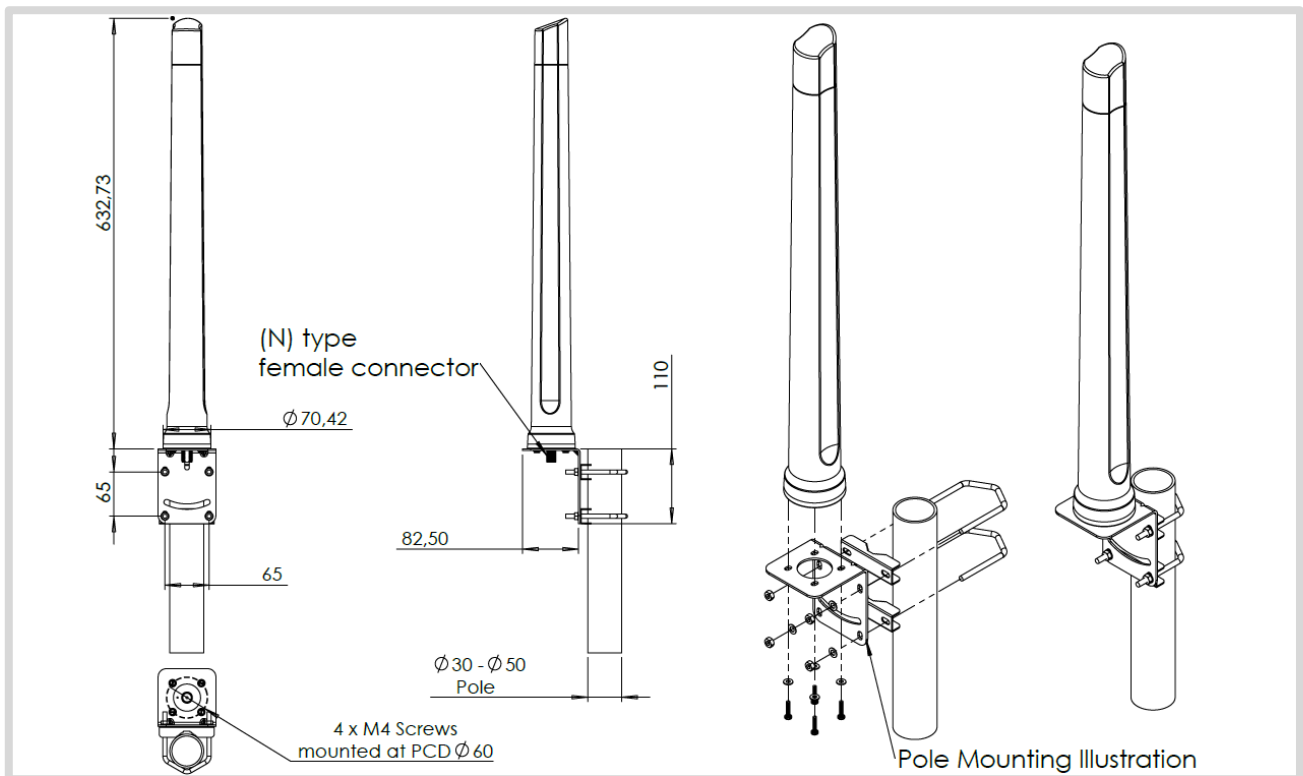

Radiation Patterns

Azimuth: 617 – 960 MHz Azimuth: 1427 – 1517 MHz

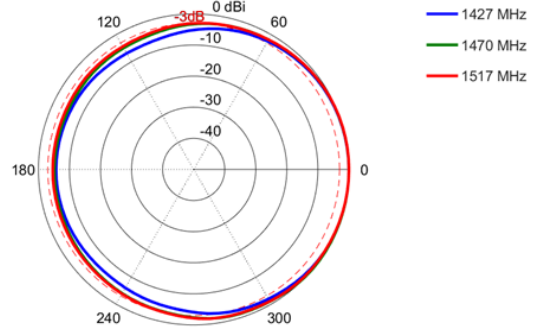
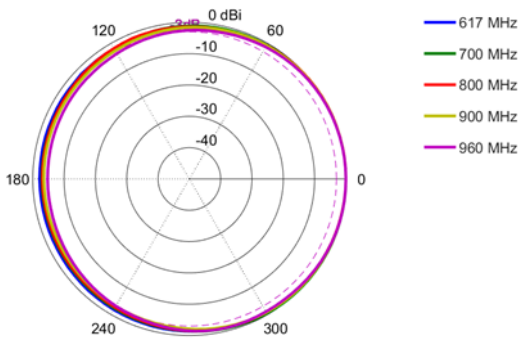

Azimuth: 1710 – 2170 MHz Azimuth: 2300 – 2700 MHz

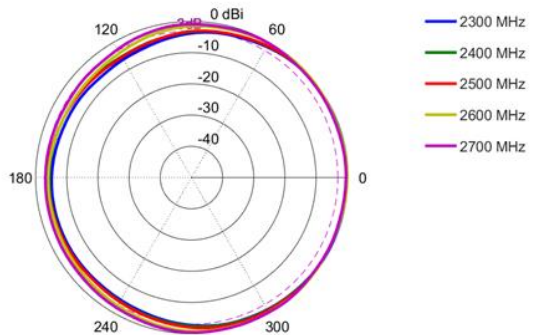
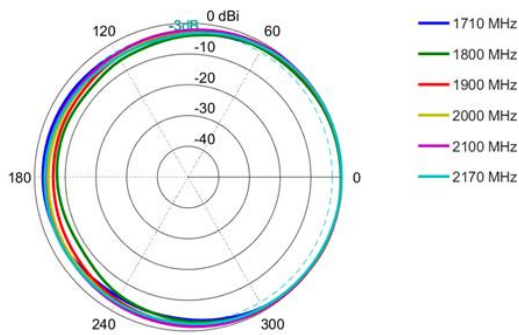

Azimuth: 3400 – 3800 MHz Elevation: 617 – 960 MHz

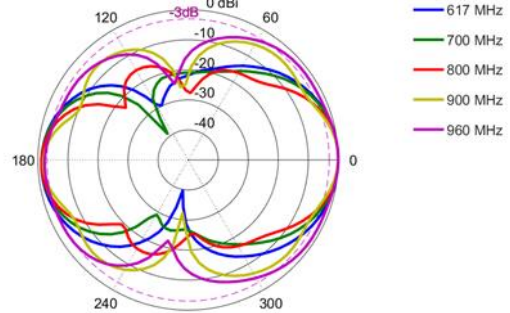
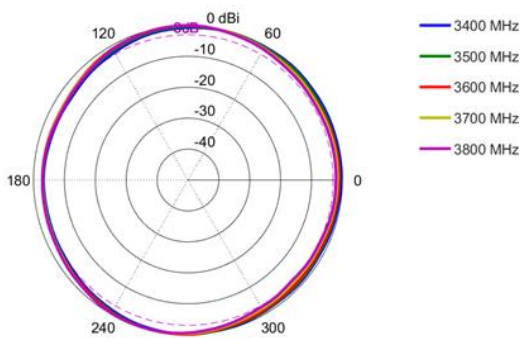

Elevation: 1427 – 1517 MHz Elevation: 1710 – 2170 MHz

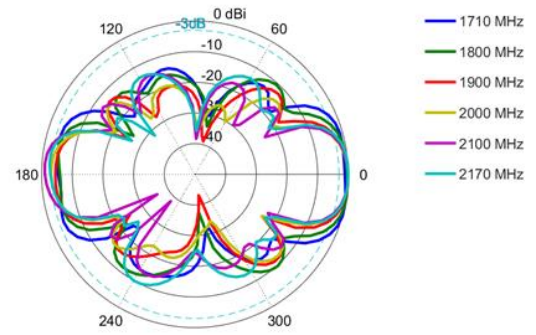
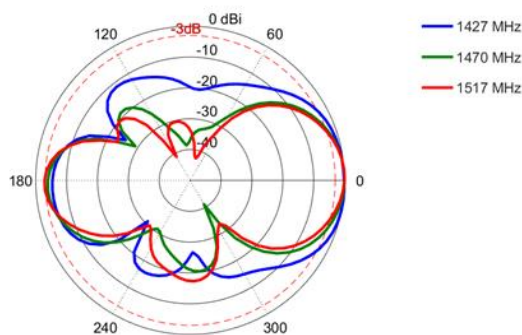

Elevation: 2300 – 2700 MHz | Elevation: 3400 – 3800 MHz

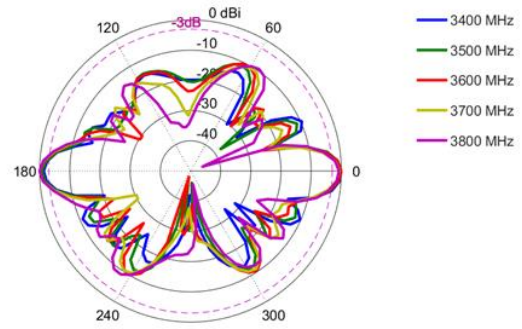
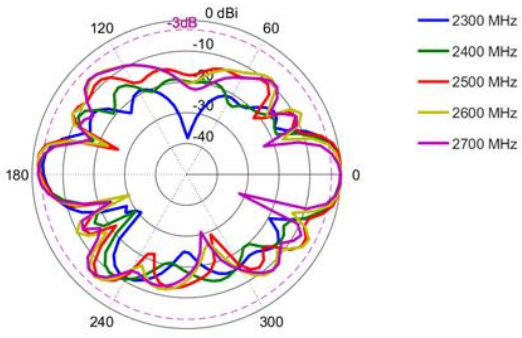

Mounting Options

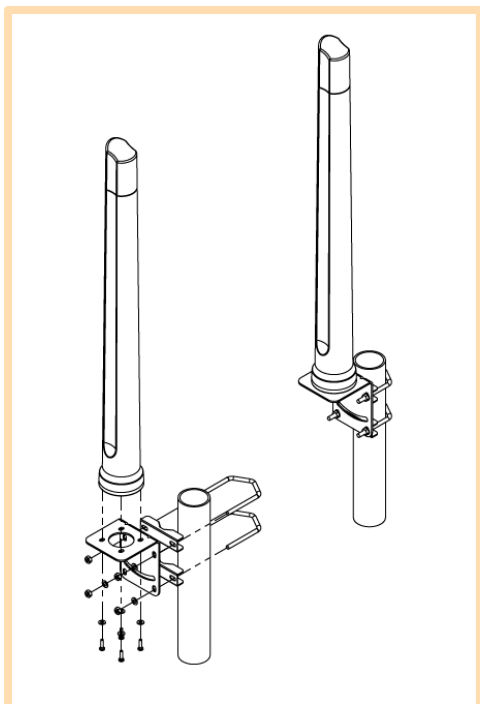

Pole Mount

L-Bracket 316 Stainless Steel – included
(for Ø 30-50mm pole)

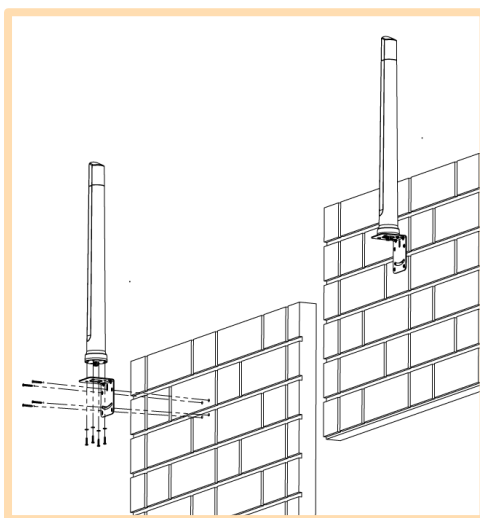

Wall Mount

L-Bracket 316 Stainless Steel – included

Additional Accessories

Extension Cables: Up to 15m HDF 195
Various connectors available
Installation poles and brackets available

See accessories technical specifications on www.poynting.tech

Contact Poynting

Poynting Antennas (Pty) Ltd - Head Office

Unit 4, N1 Industrial Park
Landmarks Avenue,
Samrand, 0157
South Africa

Phone: +27 (0) 12 657 0050

E-mail: sales@poynting.co.za

Poynting Europe

Regus Business Center Neue Messe Riem
Kronstadter Straße 4
81677 München
Germany

Phone: +49 89 208026538

E-mail: sales-europe@poynting.tech